





# ± 2g Tri-Axis Accelerometer Specifications

PART NUMBER:

KXP94

Rev. -  
Aug 07

## Product Description

The KXP94 is a tri-axis, silicon micromachined accelerometer with a full-scale output range of  $\pm 2g$  ( $19.6m/s^2$ ). The sense element is fabricated using Kionix's proprietary plasma micromachining process technology. Acceleration sensing is based on the principle of a differential capacitance arising from acceleration-induced motion of the sense element, which further utilizes common mode cancellation to decrease errors from process variation, temperature, and environmental stress. The sense element is hermetically sealed at the wafer level by bonding a second silicon lid wafer to the device using a glass frit. A separate ASIC device packaged with the sense element provides signal conditioning and self-test. The accelerometer is delivered in a 5 x 5 x 1.2 mm DFN plastic package operating from a 2.5 – 5.25V DC supply.

The three outputs (X, Y, Z) are provided on three analog output pins. The KXP94 also features an integrated **4-channel multiplexer** (X, Y, Z, Aux In).

## Functional Diagram

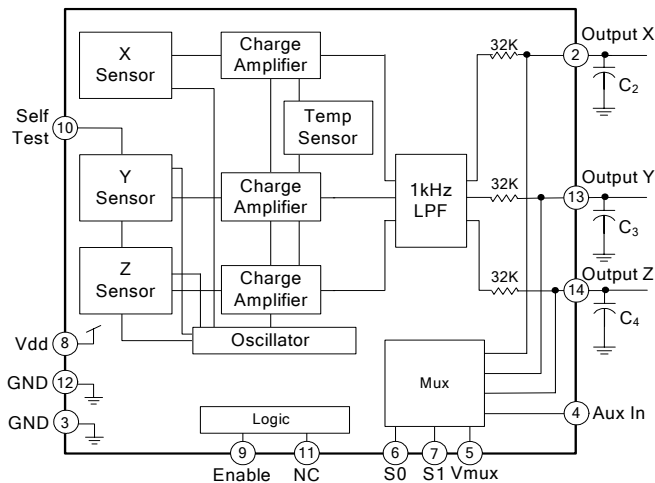

	<b>± 2g Tri-Axis Accelerometer Specifications</b>	<b>PART NUMBER:</b>  <b>KXP94</b>  <b>Rev. - Aug 07</b>
---	---	---

## Product Specifications

**Table 1. Mechanical**

**Analog** (specifications are for operation at  $V_{dd} = 3.3\text{ V}$  and  $T = 25^{\circ}\text{C}$  unless stated otherwise)

Parameters	Units	Min	Typical	Max
Operating Temperature Range	$^{\circ}\text{C}$	-40	-	85
Zero-g Offset	V	1.55	1.65	1.75
Zero-g Offset Variation from RT over Temp.	$\text{mg}/^{\circ}\text{C}$		$\pm 0.4$	
Sensitivity	$\text{mV}/\text{g}$	640	660	680
Sensitivity Variation from RT over Temp.	$\%/^{\circ}\text{C}$		$\pm 0.005$	
Offset Ratiometric Error ( $V_{dd} = 3.3\text{ V} \pm 5\%$ )	%		0.3	1.5
Sensitivity Ratiometric Error ( $V_{dd} = 3.3\text{ V} \pm 5\%$ )	%		0.4	1.5
Non-Linearity	% of FS		0.1	
Cross Axis Sensitivity	%		2.0	
Self Test Output change on Activation	g	2.2 (xy) 0.6 (z)	2.7 (xy) 1.1 (z)	3.2 (xy) 1.6 (z)
Bandwidth (-3dB) <sup>1</sup>	Hz		800	
Noise Density (on filter pins)	$\mu\text{g} / \sqrt{\text{Hz}}$		80	

Notes:

1. Internal 1 kHz low pass filter. Lower frequencies are user definable with external capacitors.

**Table 2. Electrical**

**Analog** (specifications are for operation at  $V_{dd} = 3.3\text{ V}$  and  $T = 25^{\circ}\text{C}$  unless stated otherwise)

Parameters	Units	Min	Typical	Max	
Supply Voltage ( $V_{dd}$ )	Operating	V	2.5	3.3	5.25
Current Consumption	Operating		0.95		
	Standby	$\mu\text{A}$	-	-	5
Analog Output Resistance ( $R_{out}$ )	$\text{k}\Omega$	24	32	40	
Input Low Voltage	V	-	-	$0.2 * V_{IO}$	
Input High Voltage	V	$0.8 * V_{IO}$	-	-	
Multiplexer Response Time	$\mu\text{s}$		4.5		
Power Up Time <sup>1</sup>	ms		1		

Notes:

1. Power up time can also be determined by 5 times the RC time constant of the optional user defined low pass filter.

	<b>± 2g Tri-Axis Accelerometer Specifications</b>	<b>PART NUMBER:</b>  <b>KXP94</b>  <b>Rev. - Aug 07</b>
---	---	---

**Table 3. Environmental**

Parameters		Units	Min	Target	Max
Supply Voltage (V <sub>dd</sub> )	Absolute Limits	V	-0.3	-	7.0
Maximum Operating Temperature Range		°C	-40	-	125
Storage Temperature Range		°C	-55	-	150
Mech. Shock (powered and unpowered)		g	-	-	5000 for 0.5ms
ESD	HBM	V	-	-	3000

CAUTION:  
ELECTROSTATIC  
SENSITIVE COMPONENT



Caution: ESD Sensitive and Mechanical Shock Sensitive Component, improper handling can cause permanent damage to the device.

The LGA plastic package conforms to European Union Directive 2002/95/EC on the restriction of the use of certain hazardous substances in electrical and electronic equipment (RoHS).

### Soldering

Soldering recommendations available upon request or from [www.kionix.com](http://www.kionix.com).



## ± 2g Tri-Axis Accelerometer Specifications

**PART NUMBER:**

**KXP94**

**Rev. -  
Aug 07**

### Application Schematic

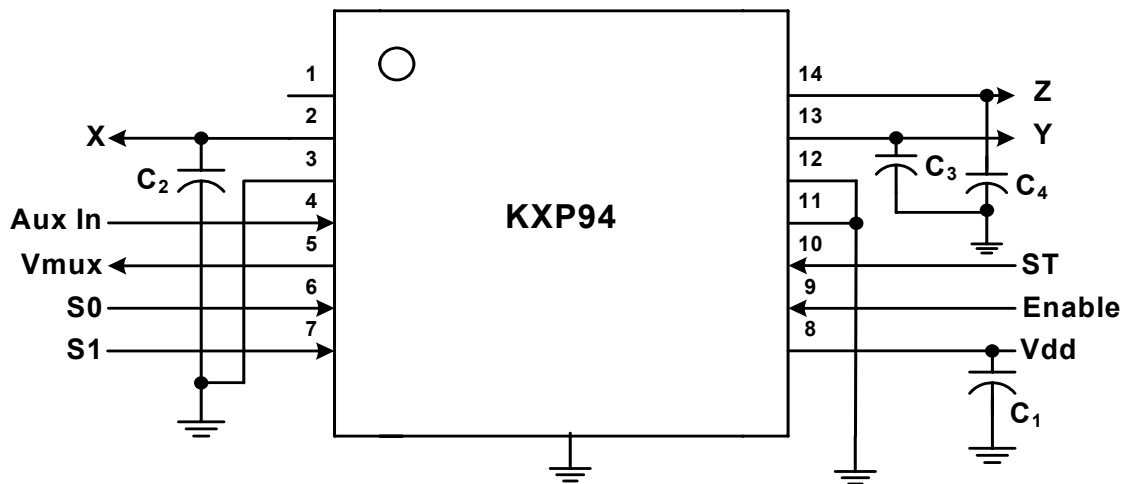

**Table 4. KXP94 Pad Descriptions**

Pad	Name	Description
1	NC	Not Connected Internally (can be connected to Vdd or Gnd)
2	X output	Analog output of the x-channel. Optionally, a capacitor ( $C_2$ ) placed between this pin and ground will form a low pass filter. <sup>1</sup>
3	GND	Ground
4	Aux In	Auxiliary input for multiplexer. <sup>2</sup>
5	Vmux	Multiplexed analog output: see Output Select Table <sup>2</sup>
6	S0	MUX selector 0: see Output Select Table <sup>2</sup>
7	S1	MUX selector 1: see Output Select Table <sup>2</sup>
8	Vdd	The power supply input. Decouple this pin to ground with a 0.1uF ceramic capacitor ( $C_1$ ).
9	Enable	Enable: <b>High</b> - Normal operation; <b>Low</b> - Device is in standby, power down mode
10	ST	Self Test: <b>Low</b> – Normal operation; <b>High</b> – Device is in self-test mode
11	NC	Not Connected Internally (can be connected to Vdd or Gnd)
12	GND	Ground
13	Y Output	Analog output of y-channel. Optionally, a capacitor ( $C_3$ ) placed between this pin and ground will form a low pass filter. <sup>1</sup>
14	Z Output	Analog output of z-channel. Optionally, a capacitor ( $C_4$ ) placed between this pin and ground will form a low pass filter. <sup>1</sup>
	Center pad	Ground



## ± 2g Tri-Axis Accelerometer Specifications

**PART NUMBER:**

**KXP94**

**Rev. -  
Aug 07**

### Application Design Notes

- The bandwidth is determined by the internal 1kHz low pass filter. The user can lower the bandwidth by placing filter capacitors connected from pins 2, 13 and 14 to ground. The response is single pole. Given a desired bandwidth,  $f_{BW}$ , the filter capacitors are determined by:

$$C_2 = C_3 = C_4 = \frac{4.97 \times 10^{-6}}{f_{BW}}$$

- When using not using the multiplexer, the KXP94 is a pin-compatible replacement for Kionix's KXM52 series of accelerometers. The following application schematic should be used:

- Pin 4 (Aux in) = Ground
- Pin 5 (Vmux) = Do Not Connect
- Pin 6 (S0) = Ground
- Pin 7 (S1) = Ground

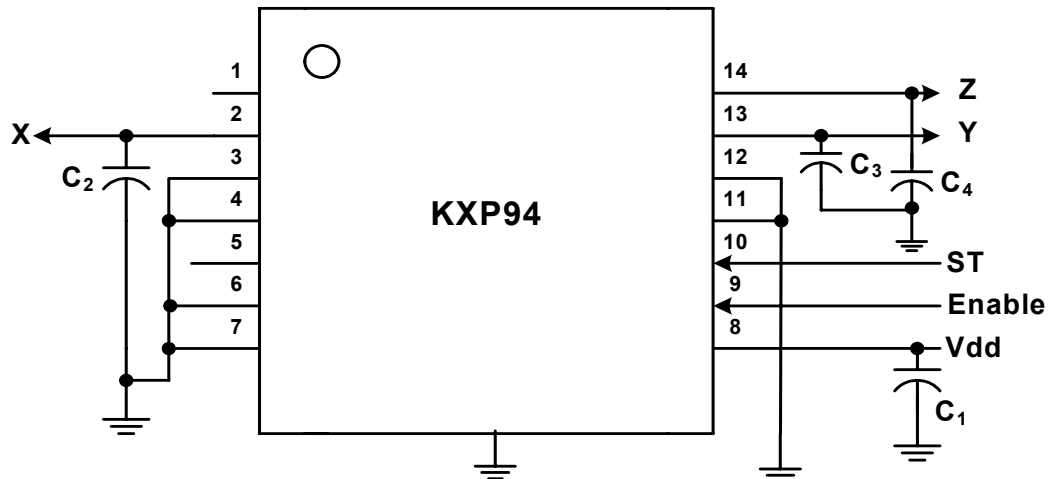

- When not connecting the self test pin to a digital I/O port of a microcontroller, Kionix recommends connecting the self test pin to ground.

	<b>± 2g Tri-Axis Accelerometer Specifications</b>	<b>PART NUMBER:</b>  <b>KXP94</b>  <b>Rev. - Aug 07</b>
---	---	---

## USING THE MULTIPLEXED OUTPUT OF THE KXP94

### ***Multiplexer Data Select***

The KXP94 features an integrated 4-channel multiplexer. This feature reduces system MCU requirements to only 1 ADC and 2 digital I/O's. The KXP94 uses two select inputs (S0, S1) to control the data flow from Vmux. When a microprocessor toggles the select inputs, the desired output is attained based on the select table. Note that logic 0 is GND and logic 1 is Vdd.

<b>S1</b>	<b>S0</b>	<b>Vmux</b>
0	0	X Output
0	1	Y Output
1	0	Z Output
1	1	Aux. In

Output Select Table

### ***Data Sampling Rate***

When operating in its multiplexed mode, the KXP94 has the ability to achieve very high data sampling rates. Internally, the sensor elements (X, Y, and Z) are sequentially sampled in a "round robin" fashion at a rate of 32KHz per axis. Note that this is a differential capacitance sampling of each sensor element, which stores an analog voltage on the filter cap for each axis. Combine this high sensor element sampling rate with the short 5µS settling time of the integrated multiplexer, and the user can achieve a performance very close to that of the 3 separate analog outputs. This is more than sufficient to eliminate any aliasing in the final application since the KXP94 will be operating with a typical bandwidth of ~50Hz and a maximum of 1000Hz.

	<b>± 2g Tri-Axis Accelerometer Specifications</b>	<b>PART NUMBER:</b>  <b>KXP94</b>  <b>Rev. - Aug 07</b>
---	---	---

[Test Specifications](#)



***Special Characteristics:***

These characteristics have been identified as being critical to the customer. Every part is tested to verify its conformance to specification prior to shipment.

**Table 5. Test Specifications**

Parameter		Specification	Test Conditions
Zero-g Offset @ RT		1.650 ± 0.100 V	25°C, V <sub>dd</sub> = 3.3V
Sensitivity @ RT		660 ± 20 mV/g	25°C, V <sub>dd</sub> = 3.3V
Current Consumption	Operating	0.5 ≤ I <sub>dd</sub> ≤ 1.4 mA	25°C, V <sub>dd</sub> = 3.3V



## ± 2g Tri-Axis Accelerometer Specifications

**PART NUMBER:**

**KXP94**

**Rev. -  
Aug 07**

### Package Dimensions and Orientation

5 x 5 x 1.2 mm DFN

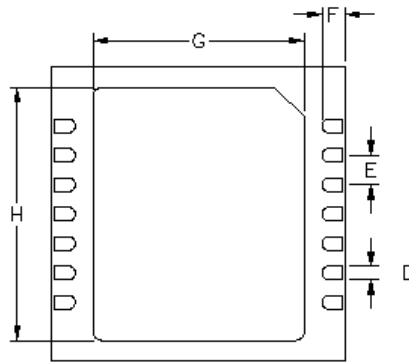
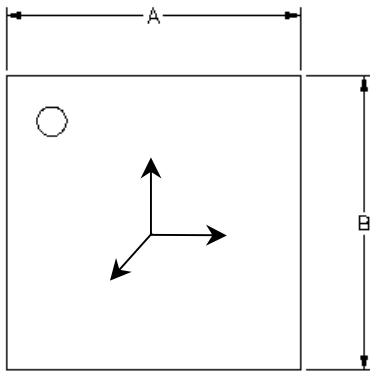

Dimension	mm			inch		
	Min	Nom	Max	Min	Nom	Max
A		5.00			0.197	
B		5.00			0.197	
C	1.10	1.20	1.30	0.043	0.047	0.051
D	0.18	0.23	0.28	0.007	0.009	0.011
E		0.50			0.020	
F	0.35	0.40	0.45	0.014	0.016	0.018
G	3.50	3.60	3.70	0.138	0.142	0.146
H	4.20	4.30	4.40	0.165	0.169	0.173

All dimensions and tolerances conform to ASME Y14.5M-1994

When device is accelerated in +X, +Y or +Z direction, the corresponding output will increase.



## ± 2g Tri-Axis Accelerometer Specifications

**PART NUMBER:**

**KXP94**

**Rev. -  
Aug 07**

### Static X/Y/Z Output Response versus Orientation to Earth's surface (1g):

Position	1	2	3	4	5	6
Diagram					Top  Bottom	Bottom  Top
X	1.65 V	2.31 V	1.65 V	0.99 V	1.65 V	1.65 V
Y	2.31 V	1.65 V	0.99 V	1.65 V	1.65 V	1.65 V
Z	1.65 V	1.65 V	1.65 V	1.65 V	2.31 V	0.99 V
X-Polarity	0	+	0	-	0	0
Y-Polarity	+	0	-	0	0	0
Z-Polarity	0	0	0	0	+	-

↓ (1g)

Earth's Surface