



± 2g Tri-axis Digital Accelerometer Specifications

PART NUMBER:

**KXSD9-2050
Rev. 3
Jul-2010**

Product Specifications

Table 1. Mechanical

(specifications are for operation at 3.3V and T = 25C unless stated otherwise)

Parameters		Units	Min	Typical	Max
Operating Temperature Range		°C	-40	-	85
Zero-g Offset		counts	1843	2048	2253
Zero-g Offset Variation from RT over Temp.		mg/°C		0.5 (xy) 3 (z)	
Sensitivity ¹	FS1=1, FS0=1 (± 2g)	counts/g	794	819	844
	FS1=1, FS0=0 (± 4g)		390	410	430
	FS1=0, FS0=1 (± 6g)		257	273	289
	FS1=0, FS0=0 (± 8g)		189	205	221
Sensitivity Variation from RT over Temp.		%/°C		0.01 (xy) 0.04 (z)	
Offset Ratiometric Error (V _{dd} = 3.3V ± 5%)		%		0.3	
Sensitivity Ratiometric Error (V _{dd} = 3.3V ± 5%)		%		1.1 (xy) 0.6 (z)	
Self Test Output change on Activation		g	1.1 0.03	1.5 (xy) 0.5 (z)	1.9 1.1
Mechanical Resonance (-3dB) ²		Hz		4000 (xy) 2000 (z)	
Non-Linearity		% of FS		0.1	
Cross Axis Sensitivity		%		2	
Noise Density (on filter pins)		µg / √Hz		750	

Notes:

1. User selectable from CTRL_REGC
2. Resonance as defined by the dampened mechanical sensor.

	± 2g Tri-axis Digital Accelerometer Specifications	PART NUMBER: KXSD9-2050 Rev. 3 Jul-2010
---	---	--

Table 2. Electrical

(specifications are for operation at 3.3V and T = 25C unless stated otherwise)

Parameters		Units	Min	Typical	Max
Supply Voltage (V _{dd})	Operating	V	1.8	3.3	3.6
I/O Pads Supply Voltage (V _{IO})		V	1.7		V _{dd}
Current Consumption	Operating (full power)	μA	120	220	320
	Motion Wake Up 15Hz Mode			40	75
	Standby			0.1	
Output Low Voltage ¹		V	-	-	0.3 * V _{IO}
Output High Voltage		V	0.9 * V _{IO}	-	-
Input Low Voltage		V	-	-	0.2 * V _{IO}
Input High Voltage		V	0.8 * V _{IO}	-	-
Input Pull-down Current		μA		0	
Power Up Time ²	LPF (-3dB) = 50Hz	ms		15.9	
	LPF (-3dB) = 100Hz			8.0	
	LPF (-3dB) = 500Hz			1.6	
	LPF (-3dB) = 1,000Hz			0.8	
	LPF (-3dB) = 2,000Hz			0.4	
A/D Conversion time		μs		200	
SPI Communication Rate ³		MHz			1
I ² C Communication Rate		KHz			400
Bandwidth (-3dB) ⁴		Hz	40	50	60

Notes:

1. Assuming I²C communication and minimum 1.5Kohm pull-up resistor on SCL and SDA.
2. Power up time is determined after the enabling of the part and is determined by the low-pass filter (LPF) set in CTRL_REGC.
3. SPI Communication Rate can be optimized for faster communication per the SPI timing diagram below.
4. Factory programmable to have a switched capacitor low pass filter at 2kHz, 1kHz, 500Hz, 100Hz, 50Hz or no low pass filter. Optionally, the user can define with in CTRL_REGC. Maximum defined by the frequency response of the sensors.



± 2g Tri-axis Digital Accelerometer Specifications

PART NUMBER:

KXSD9-2050
Rev. 3
Jul-2010

KXSD9 SPI Timing Diagram

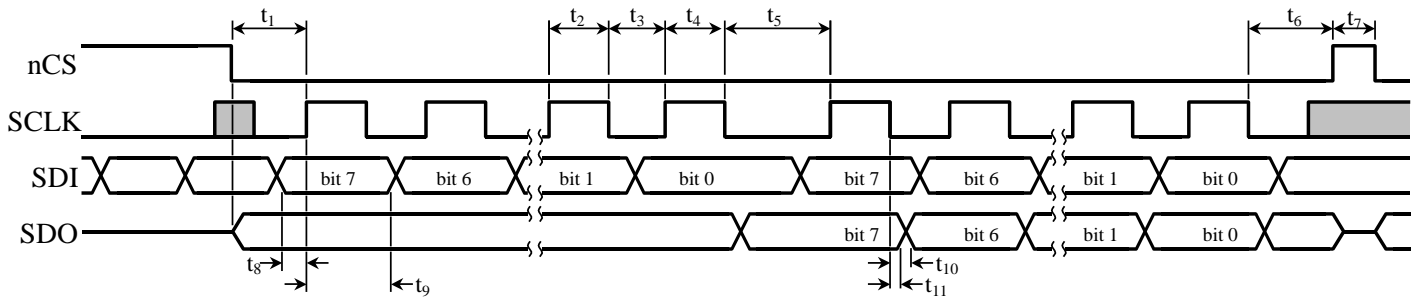

Table 3. SPI Timing

Number	Description	MIN	MAX	Units
-	Enable transition from low to high after Vdd above 1.6V	1		ms
t_1	nCS low to first SCLK setup time	130	-	ns
t_2	SCLK pulse width: high (Does not apply to the last bit of a byte.)	130	-	ns
t_3	SCLK pulse width: low (Does not apply to the last bit of a byte.)	130	-	ns
t_4	SCLK pulse width: high (Only on last bit of a byte.)	200	-	ns
t_5	SCLK pulse width: low (Only on last bit of a byte.)	350	-	ns
t_6	nCS low after the final SCLK falling edge	350	-	ns
t_7	nCS pulse width: high	130	-	ns
t_8	SDI valid to SCLK rising edge	10	-	ns
t_9	SCLK rising edge to SDI invalid	100	-	ns
t_{10}	SCLK falling edge to SDO valid	-	130	ns
t_{11}	SCLK falling edge to SDO invalid	0	-	ns
Notes	Recommended SPI SCLK	1	-	us
	A/D conversion SCLK hold (t_5)	200	-	us

	± 2g Tri-axis Digital Accelerometer Specifications	PART NUMBER: KXSD9-2050 Rev. 3 Jul-2010
---	---	--

Table 4. Environmental

Parameters		Units	Min	Typical	Max
Supply Voltage (V_{dd})	Absolute Limits	V	-0.3	-	6.0
Operating Temperature Range		°C	-40	-	85
Storage Temperature Range		°C	-55	-	150
Mech. Shock (powered and unpowered)		g	-	-	5000 for 0.5ms 10000 for 0.2ms
ESD	HBM	V	-	-	2000



Caution: ESD Sensitive and Mechanical Shock Sensitive Component, improper handling can cause permanent damage to the device.



This product conforms to Directive 2002/95/EC of the European Parliament and of the Council of the European Union (RoHS). Specifically, this product does not contain lead, mercury, cadmium, hexavalent chromium, polybrominated biphenyls (PBB), or polybrominated diphenyl ethers (PBDE) above the maximum concentration values (MCV) by weight in any of its homogenous materials. Homogenous materials are "of uniform composition throughout."



This product is halogen-free per IEC 61249-2-21. Specifically, the materials used in this product contain a maximum total halogen content of 1500 ppm with less than 900-ppm bromine and less than 900-ppm chlorine.

Soldering

Soldering recommendations are available upon request or from www.kionix.com.



± 2g Tri-axis Digital Accelerometer Specifications

PART NUMBER:

KXSD9-2050
Rev. 3
Jul-2010

Application Schematic

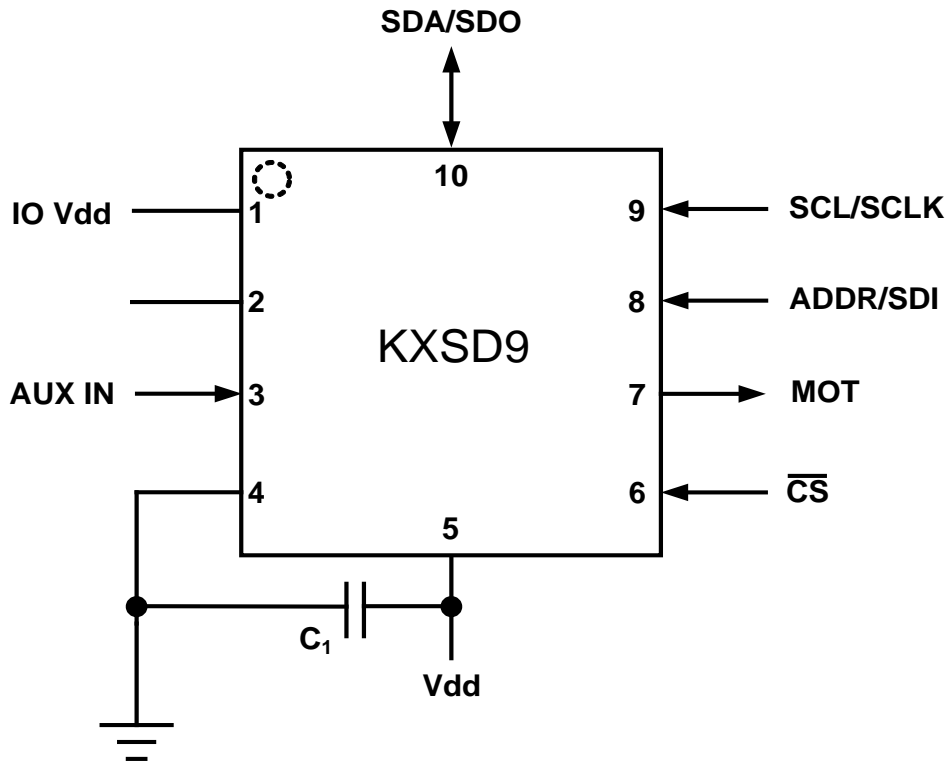



Table 5. KXSD9 Pin Descriptions

Pin	Name	Description
1	IO Vdd	The power supply input for the digital communication bus
2	DNC	Reserved – Do Not Connect
3	AUX IN	Auxiliary Input for analog/digital conversion
4	GND	Ground
5	Vdd	The power supply input. Decouple this pin to ground with a 0.1uF ceramic capacitor.
6	nCS	SPI Enable I ² C/SPI mode selection (1 = I ² C mode, 0 = SPI mode)
7	MOT	Motion Wakeup Interrupt
8	ADDR/SDI	I ² C programmable address bit/SPI Serial Data Input
9	SCL/SCLK	I ² C Serial Clock/SPI Serial Clock
10	SDA/SDO	I ² C Serial Data/SPI Serial Data Output

	± 2g Tri-axis Digital Accelerometer Specifications	PART NUMBER: KXSD9-2050 Rev. 3 Jul-2010
---	---	--

Test Specifications

! *Special Characteristics:*

These characteristics have been identified as being critical to the customer. Every part is tested to verify its conformance to specification prior to shipment.

Table 6. Test Specifications

Parameter	Specification	Test Conditions
Zero-g Offset @ RT	2048 +/- 205 counts	25C, Vdd = 3.3 V
Sensitivity @ RT	819 +/- 25 counts/g	25C, Vdd = 3.3 V
Current Consumption -- Operating	120 <= Idd <= 320 uA	25C, Vdd = 3.3 V



± 2g Tri-axis Digital Accelerometer Specifications

PART NUMBER:

KXSD9-2050
Rev. 3
Jul-2010

Package Dimensions and Orientation

3 x 3 x 0.9 mm LGA

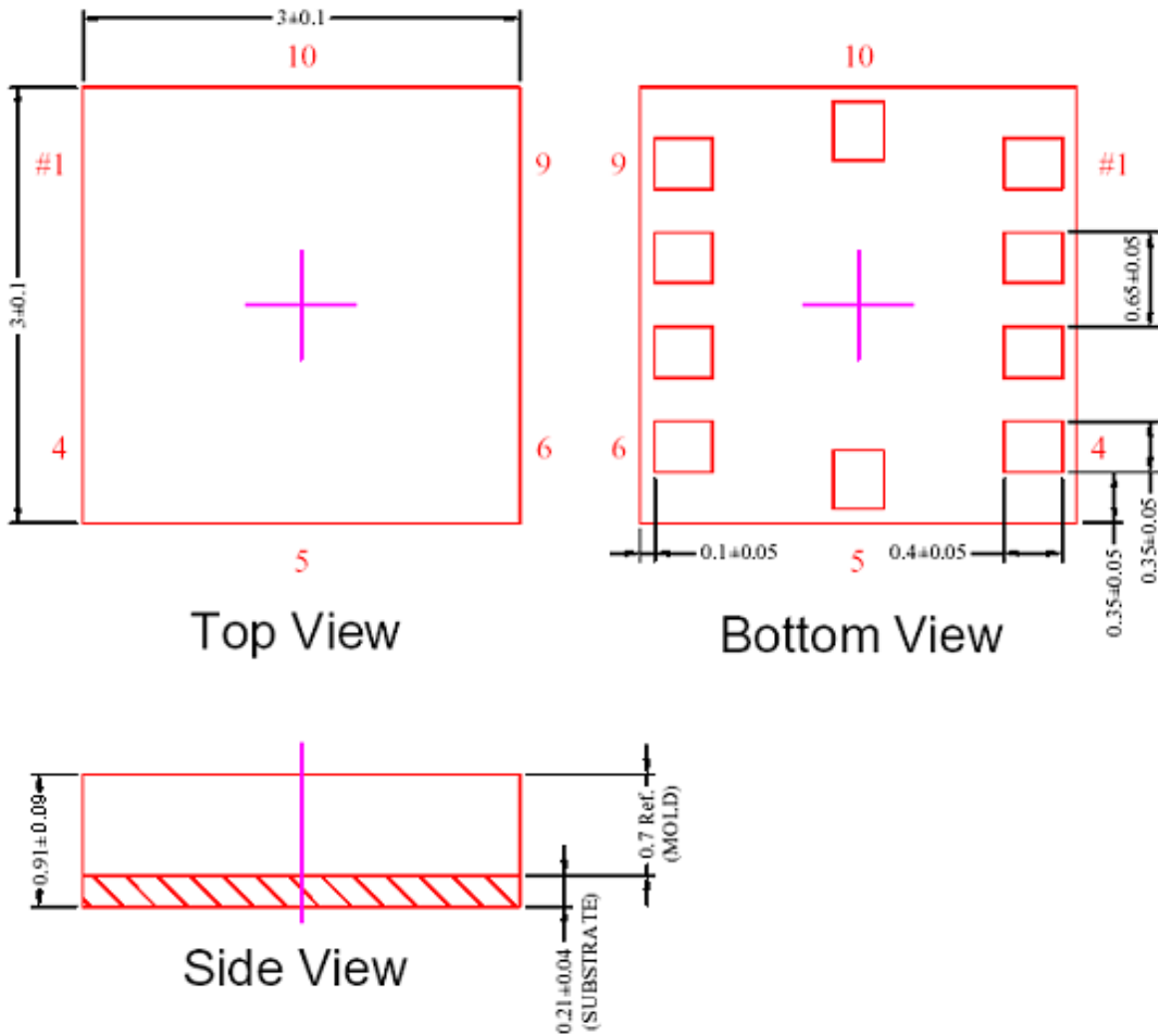

All dimensions and tolerances conform to ASME Y14.5M-1994



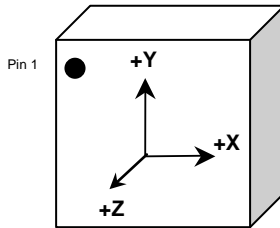

	± 2g Tri-axis Digital Accelerometer Specifications	PART NUMBER: KXSD9-2050 Rev. 3 Jul-2010
---	---	--

Orientation



When device is accelerated in +X, +Y or +Z direction, the corresponding output will increase.

Static X/Y/Z Output Response versus Orientation to Earth's surface (1-g):
 FS1=1, FS0=1 (± 2g)

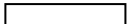
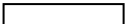
Position	1	2	3	4	5	6
Diagram					Top  Bottom	Bottom  Top
X	2048 counts	2867 counts	2048 counts	1229 counts	2048 counts	2048 counts
Y	2867 counts	2048 counts	1229 counts	2048 counts	2048 counts	2048 counts
Z	2048 counts	2048 counts	2048 counts	2048 counts	2867 counts	1229 counts
X-Polarity	0	+	0	-	0	0
Y-Polarity	+	0	-	0	0	0
Z-Polarity	0	0	0	0	+	-

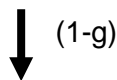

Earth's Surface

	± 2g Tri-axis Digital Accelerometer Specifications	PART NUMBER: KXSD9-2050 Rev. 3 Jul-2010
---	---	--

KXSD9 Digital Interfaces

The Kionix KXSD9 digital accelerometer has the ability to communicate on both I²C and SPI digital serial interface busses. This flexibility allows for easy system integration by eliminating analog-to-digital converter requirements and by providing direct communication with system micro-controllers. In doing so, all of the digital communication pins have shared responsibilities.

The serial interface terms and descriptions as indicated in Table 7 below will be observed throughout this document.

Term	Description
Transmitter	The device that transmits data to the bus.
Receiver	The device that receives data from the bus.
Master	The device that initiates a transfer, generates clock signals and terminates a transfer.
Slave	The device addressed by the Master.

Table 7. Serial Interface Terminologies

I²C Serial Interface

The KXSD9 has the ability to communicate on an I²C bus. I²C is primarily used for synchronous serial communication between a Master device and one or more Slave devices. The Master, typically a micro controller, provides the serial clock signal and addresses Slave devices on the bus. The KXSD9 always operates as a Slave device during standard Master-Slave I²C operation as shown in Figure 1 on the following page.

I²C is a two-wire serial interface that contains a Serial Clock (SCL) line and a Serial Data (SDA) line. SCL is a serial clock that is provided by the Master, but can be held low by any Slave device, putting the Master into a wait condition. SDA is a bi-directional line used to transmit and receive data to and from the interface. Data is transmitted MSB (Most Significant Bit) first in 8-bit per byte format, and the number of bytes transmitted per transfer is unlimited. The I²C bus is considered free when both lines are high.



± 2g Tri-axis Digital Accelerometer Specifications

PART NUMBER:

KXSD9-2050
Rev. 3
Jul-2010

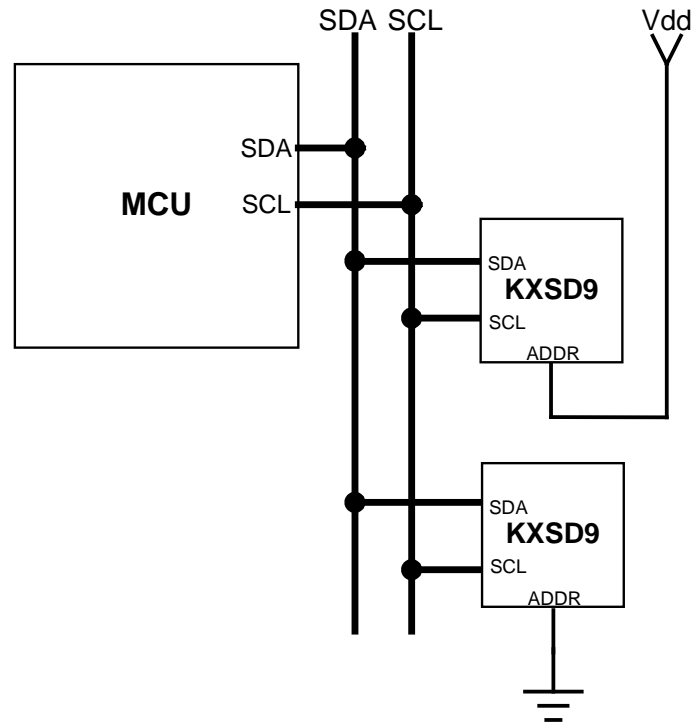



Figure 1 Multiple KXSD9 I²C Connection

I²C Operation

Transactions on the I²C bus begin after the Master transmits a start condition (S), which is defined as a high-to-low transition on the data line while the SCL line is held high. The bus is considered busy after this condition. The next byte of data transmitted after the start condition contains the Slave Address (SAD) in the seven MSBs (Most Significant Bits), and the LSB (Least Significant Bit) tells whether the Master will be receiving data '1' from the Slave or transmitting data '0' to the Slave. When a Slave Address is sent, each device on the bus compares the seven MSBs with its internally-stored address. If they match, the device considers itself addressed by the Master. The KXSD9's Slave Address is comprised of a programmable part and a fixed part, which allows for connection of multiple KXSD9's to the same I²C bus. The Slave Address associated with the KXSD9 is 001100X, where the programmable bit, X, is determined by the assignment of ADDR (pin 8) to GND or Vdd. Figure 1 above shows how two KXSD9's would be implemented on an I²C bus.

It is mandatory that receiving devices acknowledge (ACK) each transaction. Therefore, the transmitter must release the SDA line during this ACK pulse. The receiver then pulls the data line low so that it remains stable low during the high period of the ACK clock pulse. A receiver that has been addressed, whether it is Master or Slave, is obliged to generate an ACK after each byte of data has been received. To conclude a transaction, the Master must transmit a stop condition (P) by transitioning the SDA line from low to high while SCL is high. The I²C bus is now free.

	± 2g Tri-axis Digital Accelerometer Specifications	PART NUMBER: KXSD9-2050 Rev. 3 Jul-2010
---	---	--

Writing to a KXSD9 8-bit Register

Upon power up, the Master must write to the KXSD9's control registers to set its operational mode. Therefore, when writing to a control register on the I²C bus, as shown Sequence 1 on the following page, the following protocol must be observed: After a start condition, SAD+W transmission, and the KXSD9 ACK has been returned, an 8-bit Register Address (RA) command is transmitted by the Master. This command is telling the KXSD9 to which 8-bit register the Master will be writing the data. Since this is I²C mode, the MSB of the RA command should always be zero (0). The KXSD9 acknowledges the RA and the Master transmits the data to be stored in the 8-bit register. The KXSD9 acknowledges that it has received the data and the Master transmits a stop condition (P) to end the data transfer. The data sent to the KXSD9 is now stored in the appropriate register. The KXSD9 automatically increments the received RA commands and, therefore, multiple bytes of data can be written to sequential registers after each Slave ACK as shown in Sequence 2 on the following page.

Reading from a KXSD9 8-bit Register

When reading data from a KXSD9 8-bit register on the I²C bus, as shown in Sequence 3 on the next page, the following protocol must be observed: The Master first transmits a start condition (S) and the appropriate Slave Address (SAD) with the LSB set at '0' to write. The KXSD9 acknowledges and the Master transmits the 8-bit RA of the register it wants to read. The KXSD9 again acknowledges, and the Master transmits a repeated start condition (Sr). After the repeated start condition, the Master addresses the KXSD9 with a '1' in the LSB (SAD+R) to read from the previously selected register. The Slave then acknowledges and transmits the data from the requested register. The Master does not acknowledge (NACK) it received the transmitted data, but transmits a stop condition to end the data transfer. Note that the KXSD9 automatically increments through its sequential registers, allowing data reads from multiple registers following a single SAD+R command as shown below in Sequence 4 on the following page.

If a receiver cannot transmit or receive another complete byte of data until it has performed some other function, it can hold SCL low to force the transmitter into a wait state. Data transfer only continues when the receiver is ready for another byte and releases SCL. For instance, after the Master has requested to read acceleration data from the KXSD9, the KXSD9 can hold SCL low to force the Master into a wait state while it completes the A/D conversion. After the A/D conversion, the KXSD9 will release SCL and transmit the acceleration data to the Master. Note that the KXSD9 will hold for A/D conversions only if the CLKhd bit is set in CTRL_REGB.

Data Transfer Sequences

The following information clearly illustrates the variety of data transfers that can occur on the I²C bus and how the Master and Slave interact during these transfers. Table 8 on the following page defines the I²C terms used during the data transfers.



± 2g Tri-axis Digital Accelerometer Specifications

PART NUMBER:

**KXSD9-2050
Rev. 3
Jul-2010**

Term	Definition
S	Start Condition
Sr	Repeated Start Condition
SAD	Slave Address
W	Write Bit
R	Read Bit
ACK	Acknowledge
NACK	Not Acknowledge
RA	Register Address
Data	Transmitted/Received Data
P	Stop Condition

Table 8. I²C Terms

Sequence 1. The Master is writing one byte to the Slave.

Master	S	SAD + W		RA		DATA		P
Slave			ACK		ACK		ACK	

Sequence 2. The Master is writing multiple bytes to the Slave.

Master	S	SAD + W		RA		DATA		DATA		P
Slave			ACK		ACK		ACK		ACK	

Sequence 3. The Master is receiving one byte of data from the Slave.

Master	S	SAD + W		RA		Sr	SAD + R			NACK	P
Slave			ACK		ACK			ACK	DATA		

Sequence 4. The Master is receiving multiple bytes of data from the Slave.

Master	S	SAD + W		RA		Sr	SAD + R			ACK		NACK	P
Slave			ACK		ACK			ACK	DATA		DATA		

Sequence 5. The Master is receiving acceleration bytes from the Slave (ADDR = 0, CLKHld = 1).

Master	S	0x30h		0x00h	200µS	Sr	0x31h			ACK		
Slave			ACK		ACK	CLKHld			ACK	XOUT_H		XOUT_L

Master	ACK		ACK		ACK		ACK		NACK	P
Slave		YOUT_H		YOUT_L		ZOUT_H		ZOUT_L		



± 2g Tri-axis Digital Accelerometer Specifications

PART NUMBER:

KXSD9-2050
Rev. 3
Jul-2010

SPI Interface

The KXSD9 also utilizes an integrated Serial Peripheral Interface (SPI) for digital communication. The SPI interface is primarily used for synchronous serial communication between one Master device and one or more Slave devices. The Master, typically a micro controller, provides the SPI clock signal (SCLK) and determines the state of Chip Select (nCS). The KXSD9 always operates as a Slave device during standard Master-Slave SPI operation.

SPI is a 4-wire synchronous serial interface that uses two control and two data lines. With respect to the Master, the Serial Clock output (SCLK), the Data Output (SDI or MOSI) and the Data Input (SDO or MISO) are shared among the Slave devices. The Master generates an independent Chip Select (nCS) for each Slave device that goes low at the start of transmission and goes back high at the end. The Slave Data Output (SDO) line, remains in a high-impedance (hi-z) state when the device is not selected, so it does not interfere with any active devices. This allows multiple Slave devices to share a master SPI port as shown in Figure 2 below.

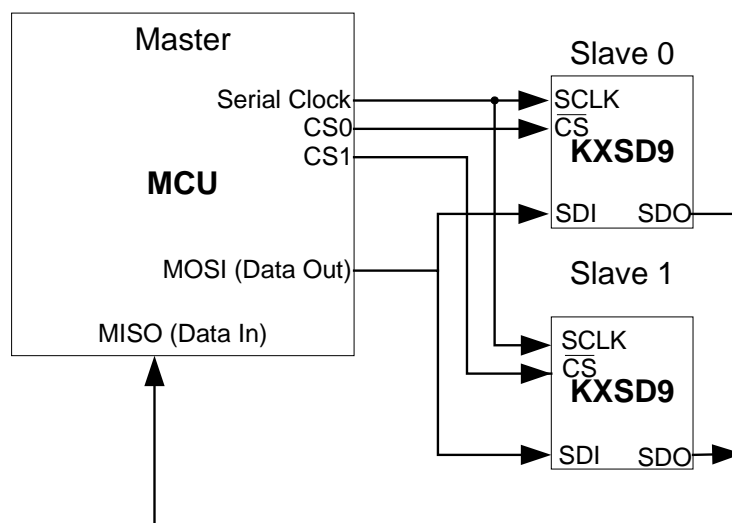

Figure 2 KXSD9 SPI Connections

Read and Write Control Registers

The control registers embedded in the KXSD9 have 8-bit addresses. Upon power up, the Master must write to the accelerometer's control registers to set its operational mode. On the falling edge of nCS, a 2-byte command is written to the appropriate control register. The first byte initiates the write to the appropriate register, and is followed by the user-defined, operational-mode byte. The MSB (Most Significant Bit) of the control register address byte will indicate "0" when writing to the register and "1" when reading from the register. This operation occurs over 16 clock cycles. All commands are sent MSB first,

	± 2g Tri-axis Digital Accelerometer Specifications	PART NUMBER: KXSD9-2050 Rev. 3 Jul-2010
---	---	--

and the host must return nCS high for at least 130nS before the next data request. Figure 3 below shows the timing diagram for carrying out the 8-bit control register write operation.

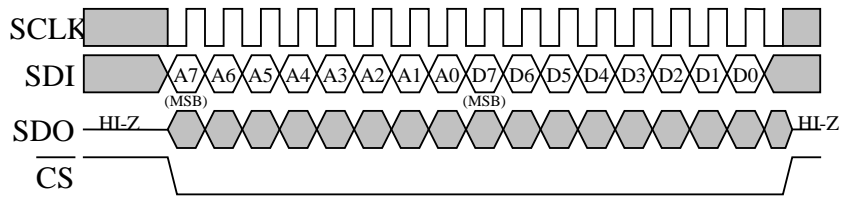

Figure 3 Timing Diagram for 8-Bit Control Register Write Operation

In order to read an 8-bit control register, an 8-bit read command must be written to the accelerometer to initiate the read. The MSB of this control register address byte will indicate “0” when writing to the register and “1” when reading from the register. Upon receiving the command, the accelerometer returns the 8-bit operational-mode data stored in the appropriate control register. This operation also occurs over 16 clock cycles. All returned data is sent MSB first, and the host must return nCS high for at least 130nS before the next data request. Figure 4 shows the timing diagram for an 8-bit control register read operation.

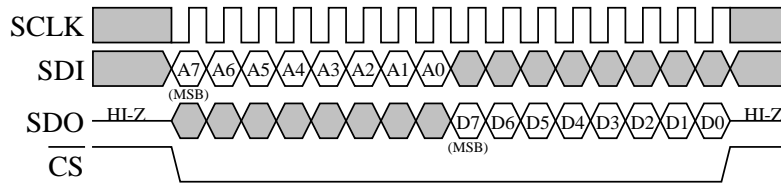

Figure 4 Timing Diagram for 8-Bit Control Register Read Operation

Accelerometer Read Back Operation

The KXSD9 has an onboard 12-bit ADC that can sample, convert and read back sensor data at any time. Transmission of an 8-bit axis-conversion command (see Table 10) begins on the falling edge of nCS. The MSB of this command indicates if you are writing to (0) or reading from (1) the register. After the eight clock cycles used to send the command, the host must hold SCLK low for at least 200µs during the A/D conversion time. Note that all returned data is sent MSB first. Once the data is received, nCS must be returned high for at least 130nS before the next data request. Figure 5 on the following page shows the timing and diagram for the accelerometer 12-bit ADC read operation.

The Read Back Operation is a 3-byte SPI command. The first byte of SDI contains the command to convert one of the axes. The second and third bytes of SDO contain the 12 bits of the A/D result plus four bits of padding in the LSB to make a total of 16 bits. See Figure 6 below.



± 2g Tri-axis Digital Accelerometer Specifications

PART NUMBER:

KXSD9-2050
Rev. 3
Jul-2010

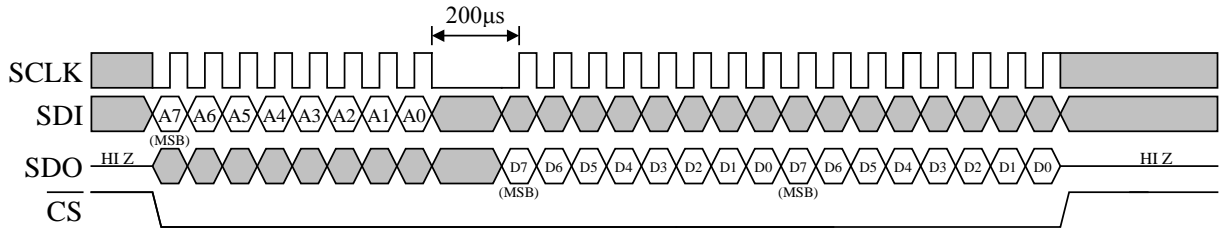

Figure 5 Timing Diagram for an A/D conversion and 12-Bit data read operation.

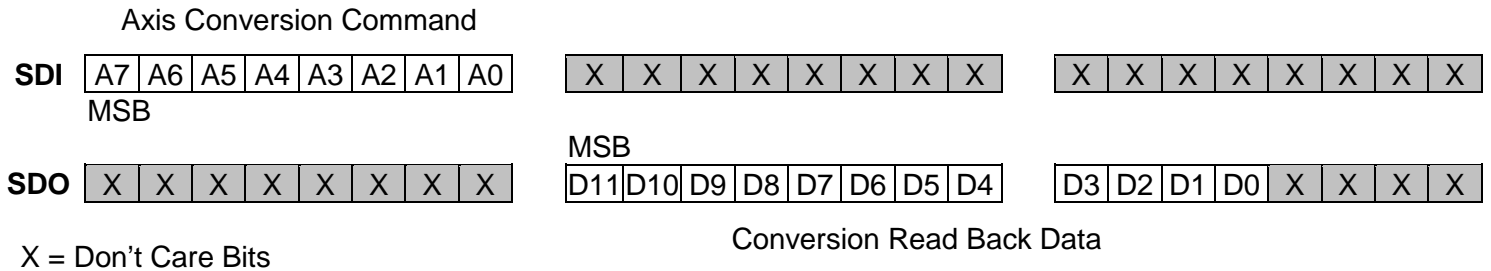

Figure 6 Register Diagram for 12-Bit ADC Read Operation

Digital Accelerometer SPI Sequence

An example of a SPI sequence for reading sensor data using the auto-increment feature is as follows:

- Power up digital accelerometer
- nCS low to select
- Write operational mode commands to the 8-bit control registers CTRL_REGB and CTRL_REGC
- nCS high for at least 130nS
- nCS low to select
- Send convert axis command
 - There should be a minimum of 200µs between the command byte and readback bytes in order to give the A/D conversion adequate time to complete.
- The 12-bit A/D data is read to the second and third SDO bytes.
 - The KXSD9 auto-increments register transmits on SDO. Therefore, Y-axis, Z-axis, AuxOut, CTRL_REGC, CTRL_REGB, and CTRL_REGA will follow the two X-axis bytes automatically.
- After receiving the last byte of required data, return nCS high for at least 130nS to reset the auto-increment.
- Repeat data read cycle
- Recommend reading X-axis, Y-axis, Z-axis, and the three Control Registers for each read cycle to verify the mode selections and status



± 2g Tri-axis Digital Accelerometer Specifications

PART NUMBER:

**KXSD9-2050
Rev. 3
Jul-2010**

KXSD9 Embedded Registers

The KXSD9 has 12 embedded 8-bit registers that are accessible by the user. This section contains the addresses and describes bit functions all embedded registers. Table 9 and Table 10 below list the accessible 8-bit registers and their addresses when in I²C mode and SPI Mode.

Register Name	Type Read/Write	Address	
		Hex	Binary
XOUT_H	R	0x00	0000 0000
XOUT_L	R	0x01	0000 0001
YOUT_H	R	0x02	0000 0010
YOUT_L	R	0x03	0000 0011
ZOUT_H	R	0x04	0000 0100
ZOUT_L	R	0x05	0000 0101
AUXOUT_H	R	0x06	0000 0110
AUXOUT_L	R	0x07	0000 0111
-	-	xxxx	xxxx xxxx
-	-	xxxx	xxxx xxxx
Reset_write	W	0x0A	0000 1010
-	-	xxxx	xxxx xxxx
CTRL_REGC	R/W	0x0C	0000 1100
CTRL_REGB	R/W	0x0D	0000 1101
CTRL_REGA	R	0x0E	0000 1110

Table 9. I²C Mode Register Map

Register Name	Type Read/Write	Read Address		Write Address	
		Hex	Binary	Hex	Binary
XOUT_H	R	0x80	1000 0000	xxxx	xxxx xxxx
XOUT_L	R	0x81	1000 0001	xxxx	xxxx xxxx
YOUT_H	R	0x82	1000 0010	xxxx	xxxx xxxx
YOUT_L	R	0x83	1000 0011	xxxx	xxxx xxxx
ZOUT_H	R	0x84	1000 0100	xxxx	xxxx xxxx
ZOUT_L	R	0x85	1000 0101	xxxx	xxxx xxxx
AUXOUT_H	R	0x86	1000 0110	xxxx	xxxx xxxx
AUXOUT_L	R	0x87	1000 0111	xxxx	xxxx xxxx
-	-	xxxx	xxxx xxxx	xxxx	xxxx xxxx
-	-	xxxx	xxxx xxxx	xxxx	xxxx xxxx
Reset_write	W	xxxx	xxxx xxxx	0x0A	0000 1010
-	-	xxxx	xxxx xxxx	xxxx	xxxx xxxx
CTRL_REGC	R/W	0x8C	1000 1100	0x0C	0000 1100
CTRL_REGB	R/W	0x8D	1000 1101	0x0D	0000 1101
CTRL_REGA	R	0x8E	1000 1110	xxxx	xxxx xxxx

Table 10. SPI Mode Register Map



± 2g Tri-axis Digital Accelerometer Specifications

PART NUMBER:

KXSD9-2050
Rev. 3
Jul-2010

Register Descriptions

XOUT_H

X-axis accelerometer output most significant byte

R	R	R	R	R	R	R	R
XOUTD11	XOUTD10	XOUTD9	XOUTD8	XOUTD7	XOUTD6	XOUTD5	XOUTD4
Bit7	Bit6	Bit5	Bit4	Bit3	Bit2	Bit1	Bit0

I²C Address: 0x00h

SPI Read Address: 0x80h

XOUT_L

X-axis accelerometer output least significant byte

R	R	R	R	R	R	R	R
XOUTD3	XOUTD2	XOUTD1	XOUTD0	X	X	X	X
Bit7	Bit6	Bit5	Bit4	Bit3	Bit2	Bit1	Bit0

I²C Address: 0x01h

SPI Read Address: 0x81h

YOUT_H

Y-axis accelerometer output most significant byte

R	R	R	R	R	R	R	R
YOUTD11	YOUTD10	YOUTD9	YOUTD8	YOUTD7	YOUTD6	YOUTD5	YOUTD4
Bit7	Bit6	Bit5	Bit4	Bit3	Bit2	Bit1	Bit0

I²C Address: 0x02h

SPI Read Address: 0x82h

YOUT_L

Y-axis accelerometer output least significant byte

R	R	R	R	R	R	R	R
YOUTD3	YOUTD2	YOUTD1	YOUTD0	X	X	X	X
Bit7	Bit6	Bit5	Bit4	Bit3	Bit2	Bit1	Bit0

I²C Address: 0x03h

SPI Read Address: 0x83h

ZOUT_H

Z-axis accelerometer output most significant byte

R R R R R R R R



± 2g Tri-axis Digital Accelerometer Specifications

PART NUMBER:

**KXSD9-2050
Rev. 3
Jul-2010**

ZOUTD11	ZOUTD10	ZOUTD9	ZOUTD8	ZOUTD7	ZOUTD6	ZOUTD5	ZOUTD4
Bit7	Bit6	Bit5	Bit4	Bit3	Bit2	Bit1	Bit0

I²C Address: 0x04h
SPI Read Address: 0x84h

ZOUT_L

Z-axis accelerometer output least significant byte

R	R	R	R	R	R	R	R
ZOUTD3	ZOUTD2	ZOUTD1	ZOUTD0	X	X	X	X
Bit7	Bit6	Bit5	Bit4	Bit3	Bit2	Bit1	Bit0

I2C Address: 0x05h
SPI Read Address: 0x85h

AUXOUT_H

Auxiliary output most significant byte

R	R	R	R	R	R	R	R
AUXOUTD11	AUXOUTD10	AUXOUTD9	AUXOUTD8	AUXOUTD7	AUXOUTD6	AUXOUTD5	AUXOUTD4
Bit7	Bit6	Bit5	Bit4	Bit3	Bit2	Bit1	Bit0

I²C Address: 0x06h
SPI Read Address: 0x86h

AUXOUT_L

Auxiliary output least significant byte

R	R	R	R	R	R	R	R
AUXOUTD3	AUXOUTD2	AUXOUTD1	AUXOUTD0	X	X	X	X
Bit7	Bit6	Bit5	Bit4	Bit3	Bit2	Bit1	Bit0

I2C Address: 0x07h
SPI Read Address: 0x87h

Reset_write

When the key (11001010) is written to this register the offset, sensitivity and temperature correction values will be loaded into RAM and used for all further measurements. This is also accomplished at power-up by an internal power-up reset circuit.

W	W	W	W	W	W	W	W
1	1	0	0	1	0	1	0
Bit7	Bit6	Bit5	Bit4	Bit3	Bit2	Bit1	Bit0

I²C Address: 0x0Ah

	± 2g Tri-axis Digital Accelerometer Specifications	PART NUMBER: KXSD9-2050 Rev. 3 Jul-2010
---	---	--

SPI Write Address: 0x0Ah

CTRL_REGC

Read/write control register: Factory programmed power up/reset default value (0xE1h)

R/W	R/W	R/W	R/W	R/W	R/W	R/W	R/W	Reset Value
LP2	LP1	LP0	MOTLev	MOTLat	0	FS1	FS0	11100001
Bit7	Bit6	Bit5	Bit4	Bit3	Bit2	Bit1	Bit0	

I²C Address: 0x0Ch

SPI Read Address: 0x8Ch

SPI Write Address: 0x0Ch

FS0 is the first of two bits used to select the full scale sensing range of the accelerometer. See Table 11 below.

FS1 is the second of two bits used to select the full scale sensing range of the accelerometer. See Table 11 below.

FS1	FS0	Full Scale Range	12-bit Sensitivity
0	0	+/-8 g	205 counts/g
0	1	+/-6 g	273 counts/g
1	0	+/-4 g	410 counts/g
1	1	+/-2 g	819 counts/g

Table 11. Full Scale Range

MOTLat switches the motion wake up response function between latching and non-latching.

MOTLat = 1 - If MOTLen in CTRL_REGB is “1” and a motion event happens, the MOTI bit in CTRL_REGA will be set to “1” and the MOT pin (7) will be pulled high. The part will clear the MOTLen bit in CTRL_REGB and enter full-power mode. To re-enter low power motion wakeup mode, reset the MOTLen bit to “1”. Figure 7 shows the response of the KXSD9 as described above.

MOTLat = 0 – If MOTLen in CTRL_REGB is “1” and a motion event happens, the MOTI bit in CTRL_REGA will be set to “1” and the MOT pin (7) will be pulled high. The part will remain in low power motion wakeup mode. The MOT pin (7) can be cleared by reading CTRL_REGA. Figure 8 shows the response of the KXSD9 as described above.



± 2g Tri-axis Digital Accelerometer Specifications

PART NUMBER:
KXSD9-2050
Rev. 3
Jul-2010

Typical Motion Wake Up Interrupt Example (MOTLat = 1)

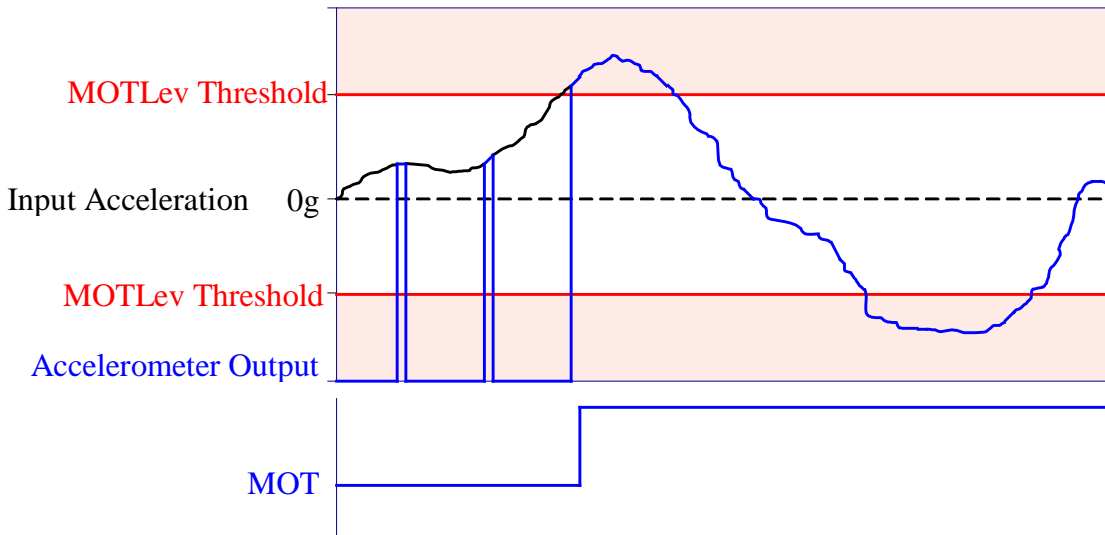

Figure 7 Latched Motion Wake Up Response



± 2g Tri-axis Digital Accelerometer Specifications

PART NUMBER:

**KXSD9-2050
Rev. 3
Jul-2010**

Typical Motion Wake Up Interrupt Example (MOTLat = 0)

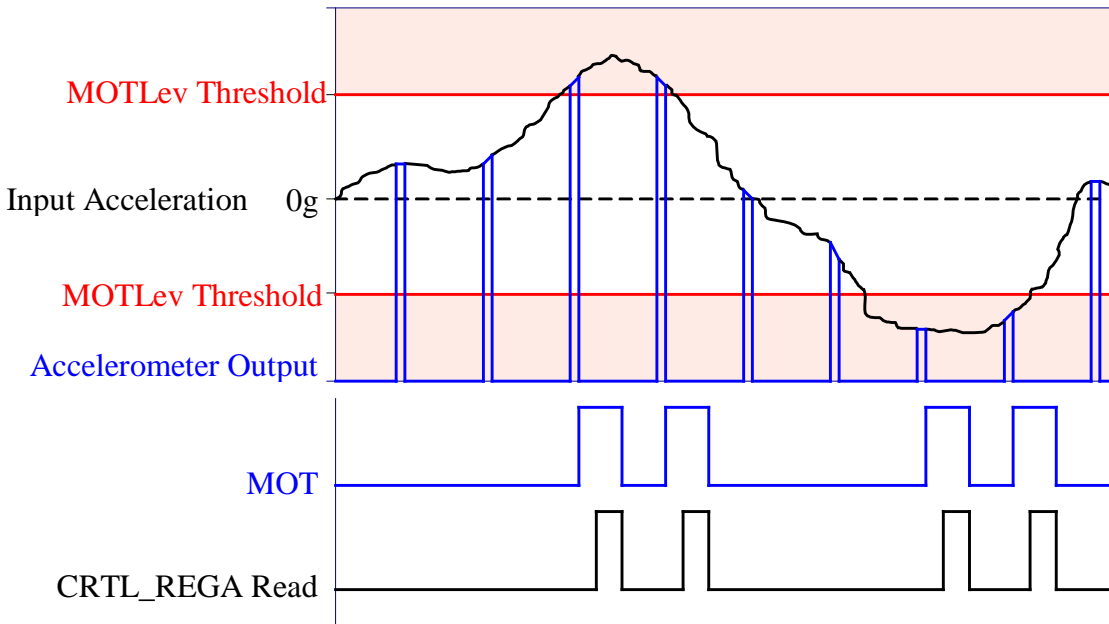

Figure 8 Unlatched Motion Wake Up Response

MOTLev sets the motion wakeup threshold to an acceleration level as defined in Table 12.

MOTLev	FS1	FS0	Motion Wake Up Threshold
0	0	0	+/-6 g
0	0	1	+/-4.5 g
0	1	0	+/-3 g
0	1	1	+/-1.5 g
1	0	0	+/-4 g
1	0	1	+/-3 g
1	1	0	+/-2 g
1	1	1	+/-1 g

Table 12. Motion Wake Up Acceleration Threshold

LP0 is the first of three bits used to select the operational bandwidth of the accelerometer. See Table 13 below.



± 2g Tri-axis Digital Accelerometer Specifications

PART NUMBER:

**KXSD9-2050
Rev. 3
Jul-2010**

LP1 is the second of three bits used to select the operational bandwidth of the accelerometer. See Table 13 below.

LP2 is the third of three bits used to select the operational bandwidth of the accelerometer. See Table 13 below.

LP2	LP1	LP0	Filter Corner Frequency
0	0	0	No Filter
0	0	1	2000 Hz
0	1	0	2000 Hz
0	1	1	2000 Hz
1	0	0	1000 Hz
1	0	1	500 Hz
1	1	0	100 Hz
1	1	1	50 Hz

Table 13. Operational Bandwidth

CTRL_REGB

Read/write control register: Factory programmed power up/reset default value (0x40h)

R/W	R/W	R/W	R/W	R/W	R/W	R/W	R/W	Reset Value
CLKhld	ENABLE	ST	0	0	MOTIen	0	0	01000000
Bit7	Bit6	Bit5	Bit4	Bit3	Bit2	Bit1	Bit0	

I²C Address: 0x0Dh

SPI Read Address: 0x8Dh

SPI Write Address: 0x0Dh

MOTIen enables the motion wakeup feature.

MOTIen = 1 – the KXSD9 will run in a low power mode until a motion event occurs that causes MOTI in CTRL_REGA and the MOT pin (7) to go high. The part then enters normal operation if MOTLat = 1 or remains in low power mode if MOTLat = 0.

MOTIen = 0 – the KXSD9 is in normal operating mode

ST activates the self-test function for the sensor elements on all three axes. A correctly functioning KXSD9 will increase all channel outputs when Self test = 1 and Enable = 1. This bit can be read or written.

Enable powers up the KXSD9 for operation.

Enable = 1 – normal operation

Enable = 0 – low-power standby

CLKhld allows the KXSD9 to hold the serial clock, SCL, low in I²C mode to force the transmitter into a wait state during A/D conversions.



± 2g Tri-axis Digital Accelerometer Specifications

PART NUMBER:

KXSD9-2050
Rev. 3
Jul-2010

CLKhld = 1 – SCL held low during A/D conversions

CLKhld = 0 – SCL unaffected

CLKhld should be set to 0 when Enable is set to 0 (disabled) to prevent potential holding of the CLK line.

CTRL_REGA

Read-only status register

R	R	R	R	R	R	R	R
X	X	X	X	X	X	MOTI	X
Bit7	Bit6	Bit5	Bit4	Bit3	Bit2	Bit1	Bit0

I²C Address: 0x0Eh

SPI Read Address: 0x8Eh

SPI Write Address: 0x0Eh

MOTI reports the status of the motion wakeup interrupt. Reading CTRL_REGA clears the MOTI bit and MOT pin (7).

MOTI = 1 - a motion wake up event has occurred and the MOT pin (7) is high.

MOTI = 0 - a motion wake up event has not occurred and the MOT pin (7) is low.

	± 2g Tri-axis Digital Accelerometer Specifications	PART NUMBER: KXSD9-2050 Rev. 3 Jul-2010
---	---	--

Revision History

REVISION	DESCRIPTION	DATE
1	Initial release	16-May-2008
2	Changed to new format & revisioning.	12-Oct-2009
3	Changed Current Consumption, Operating (15Hz) to Motion Wake Up 15Hz Mode and added typ. and max fields for it.	08-Jul-2010

"Kionix" is a registered trademark of Kionix, Inc. Products described herein are protected by patents issued or pending. No license is granted by implication or otherwise under any patent or other rights of Kionix. The information contained herein is believed to be accurate and reliable but is not guaranteed. Kionix does not assume responsibility for its use or distribution. Kionix also reserves the right to change product specifications or discontinue this product at any time without prior notice. This publication supersedes and replaces all information previously supplied.